

Application Note

Modbus/TCP of ezTCP

Version 1.6

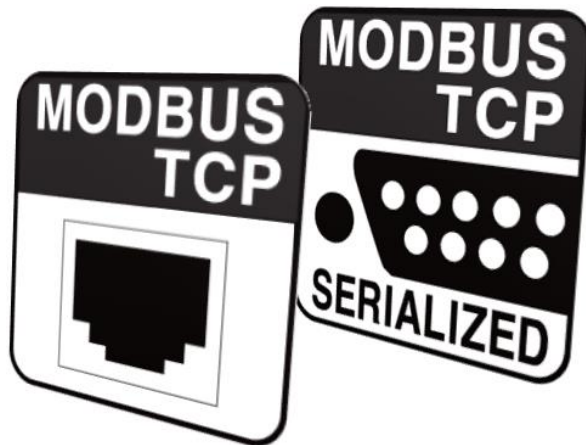

Sollae Systems Co., Ltd.

<http://www.ezTCP.com>

1 Contents

1	Contents	- 1 -
2	Introduction	- 5 -
2.1	Overview	- 5 -
2.2	Available products	- 5 -
2.3	Terms and Notations	- 6 -
2.3.1	<i>Ports of ezTCP</i>	- 6 -
2.3.2	<i>Defines of ezTCP ports</i>	- 6 -
2.3.3	<i>MSB / LSB</i>	- 6 -
2.3.4	<i>Abbreviations</i>	- 6 -
3	Protocol Overview	- 7 -
3.1	MODBUS	- 7 -
3.1.1	<i>General Description</i>	- 7 -
3.1.2	<i>Data Encoding</i>	- 7 -
3.1.3	<i>MODBUS Data model</i>	- 8 -
3.1.4	<i>Memory structure of ezTCP</i>	- 8 -
3.1.5	<i>MODBUS Addressing by HMI/SCADA with ezTCP</i>	- 9 -
3.2	Modbus/TCP.....	- 10 -
3.2.1	<i>General Description</i>	- 10 -
3.2.2	<i>Communication Model in ezTCP</i>	- 10 -
3.2.3	<i>Modbus/TCP Frame</i>	- 10 -
3.2.4	<i>MBAP Header</i>	- 11 -
3.3	Function Codes	- 12 -
3.3.1	<i>Categories</i>	- 12 -
3.3.2	<i>Public Function Codes</i>	- 13 -
3.3.3	<i>User-Defined Function Codes</i>	- 13 -
4	Public Function Codes	- 14 -
4.1	Read Coils (FC 01)	- 14 -
4.1.1	<i>Request</i>	- 14 -
4.1.2	<i>Response</i>	- 14 -
4.1.3	<i>Exception</i>	- 15 -
4.1.4	<i>Examples</i>	- 15 -
4.2	Read Discrete Inputs (FC 02)	- 16 -

4.2.1 Request.....	- 16 -
4.2.2 Response.....	- 16 -
4.2.3 Exception.....	- 17 -
4.2.4 Examples	- 17 -
4.3 Read Holding Registers (FC 03)	- 18 -
4.3.1 Request.....	- 18 -
4.3.2 Response.....	- 18 -
4.3.3 Exceptions	- 19 -
4.3.4 Examples	- 20 -
4.4 Read Input Registers (FC 04)	- 21 -
4.4.1 Request.....	- 21 -
4.4.2 Response.....	- 21 -
4.4.3 Exception.....	- 22 -
4.4.4 Examples	- 23 -
4.5 Write Single Coil (FC 05).....	- 24 -
4.5.1 Request / Response.....	- 24 -
4.5.2 Exception.....	- 24 -
4.5.3 Examples	- 25 -
4.6 Write Single Register (FC 06)	- 26 -
4.6.1 Request / Response.....	- 26 -
4.6.2 Exception.....	- 26 -
4.6.3 Examples	- 27 -
4.7 Read Exception Status (FC 07)	- 28 -
4.7.1 Request.....	- 28 -
4.7.2 Response.....	- 28 -
4.7.3 Exception.....	- 28 -
4.7.4 Examples	- 29 -
4.8 Write Multiple Coils (FC 15)	- 30 -
4.8.1 Request.....	- 30 -
4.8.2 Response.....	- 31 -
4.8.3 Exception.....	- 31 -
4.8.4 Examples	- 32 -
4.9 Write Multiple Registers (FC 16).....	- 33 -
4.9.1 Request.....	- 33 -
4.9.2 Response.....	- 33 -

4.9.3	<i>Exception</i>	- 34 -
4.9.4	<i>Examples</i>	- 34 -
4.10	Encapsulated Interface Transport (FC 43)	- 35 -
4.10.1	<i>Request</i>	- 35 -
4.10.2	<i>Response</i>	- 35 -
4.10.3	<i>Exception</i>	- 36 -
4.10.4	<i>Examples</i>	- 36 -
4.11	Read Device Identification (FC 43 / 14)	- 37 -
4.11.1	<i>Request</i>	- 38 -
4.11.2	<i>Response</i>	- 39 -
4.11.3	<i>Exception</i>	- 40 -
4.11.4	<i>Example – Basic Device Identification</i>	- 41 -
4.11.5	<i>Example – Extended Device Identification</i>	- 42 -
5	User-Defined Function Codes	- 46 -
5.1	Write Pulse (FC 105)	- 46 -
5.1.1	<i>Request / Response</i>	- 46 -
5.1.2	<i>Exception</i>	- 46 -
5.1.3	<i>Examples</i>	- 47 -
6	Additional Instructions	- 48 -
6.1	Exception Codes	- 48 -
6.2	ADC values	- 48 -
6.2.1	<i>Request</i>	- 48 -
6.2.2	<i>Response</i>	- 48 -
6.3	Using	- 49 -
6.3.1	<i>Modbus/TCP Configuration</i>	- 49 -
6.3.2	<i>Configuration Example</i>	- 50 -
6.4	Sample Codes	- 51 -
6.4.1	<i>Provided version</i>	- 51 -
7	Serialized Modbus/TCP	- 52 -
7.1	Features	- 52 -
7.2	Using	- 52 -
7.2.1	<i>Configuration</i>	- 52 -
7.3	Trial Run	- 53 -

7.3.1 *Preperations for Communication*..... - 53 -
7.3.2 *Sending an Example data*..... - 54 -
8 Precautions..... - 55 -
9 Revision History..... - 56 -



2 Introduction

2.1 Overview

MODBUS is a communication protocol widely used in the world for monitoring and control of various types of automation devices such as a PLC (Programmable Logic Controller). MODBUS is an application layer messaging protocol providing client/server communication between devices connected to different types of buses or networks. This document introduces the MODBUS messaging service over TCP/IP which is called Modbus/TCP and used in ezTCP to manage its I/O ports.

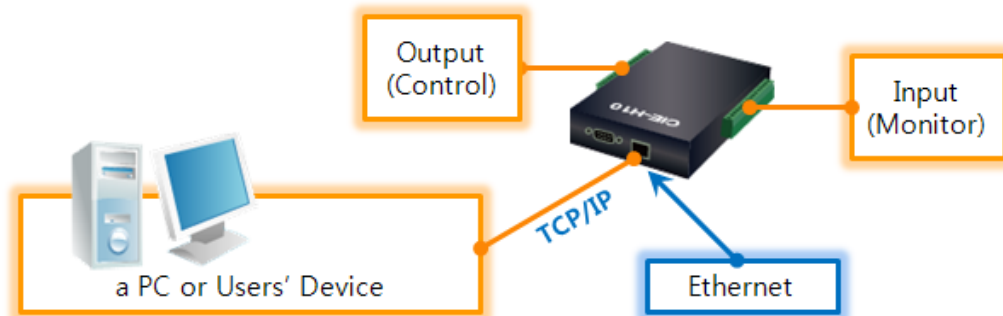

Figure 2-1 A diagram of Modbus/TCP system

ezTCP supports “Serialized Modbus/TCP” communication mode in case a user needs to communicate with ezTCP through a serial port (RS232). Note that “Serialized Modbus/TCP” does NOT mean the standard MODBUS protocol over serial line. It just sends and receives data of the Modbus/TCP via a RS232 port.

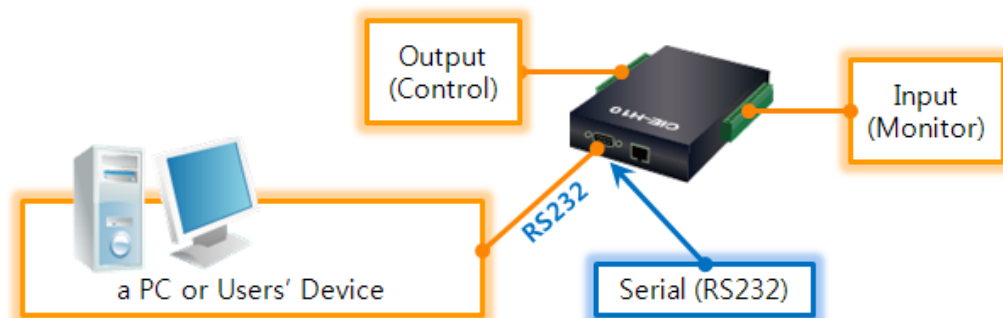

Figure 2-2 A diagram of Serialized Modbus/TCP system

2.2 Available products

- CIE-xxx series – CIE-H12, CIE-H14, CIE-H10, CIE-M10
- EZI-10

2.3 Terms and Notations

2.3.1 Ports of ezTCP

There are 3 kinds of ports in ezTCP.

- Digital Input Port
- Analog Input Port
- Digital Output Port

2.3.2 Defines of ezTCP ports

The Digital ports of ezTCP are expressed as decimal numbers with ‘#’ symbol. It is started from zero and increased by 1 in sequence. For example, CIE-H10 has 8 digital input / output ports, and they are represented as below.

- The 1st port – #0
- The 8th port – #7

2.3.3 MSB / LSB

- MSB (Most Significant Bit) – the bit position with the greatest value, the left-most bit
- LSB (Least Significant Bit) – the bit position with the least value, the right-most bit



Figure 2-3 MSB and LSB

2.3.4 Abbreviations

- ADU Application Data Unit
- HMI Human Machine Interface
- MBAP MODBUS Application Protocol
- PDU Protocol Data Unit
- SCADA Supervisory Control And Data Acquisition

3 Protocol Overview

3.1 MODBUS

3.1.1 General Description

- An application layer messaging protocol (the OSI 7 layer)
- PDU (Protocol Data Unit)
A simple data unit independent of the underlying communication layers

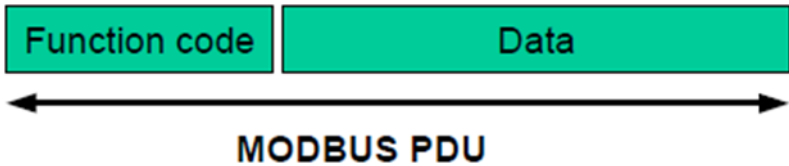

Figure 3-1 MODBUS PDU

- ADU (Application Data Unit)
A data unit of MODBUS protocol on specific buses or network, some additional fields on PDU

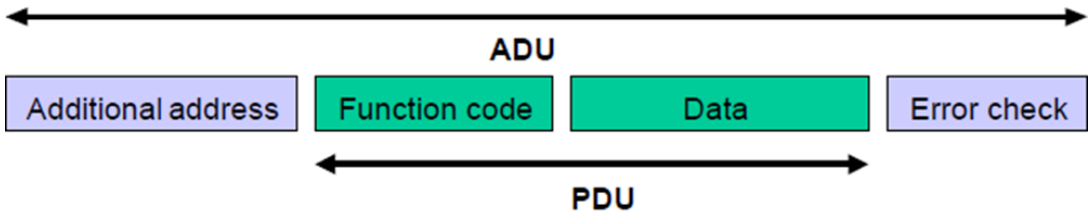

Figure 3-2 General MODBUS frame

Note that the previous figure does NOT show a Modbus/TCP frame. Refer to [3.2.3 Modbus/TCP Frame](#) for an ADU of Modbus/TCP.

- Client/Server communication model

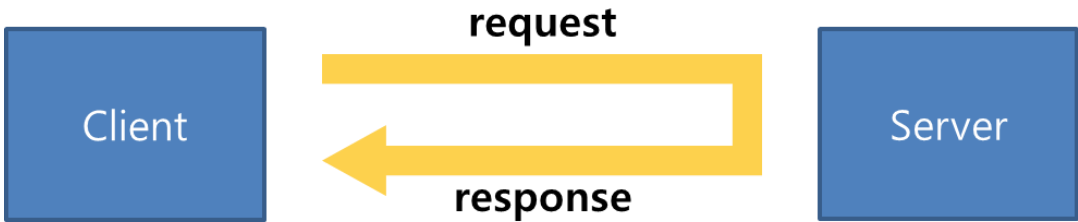

Figure 3-3 MODBUS Client/Server Model

3.1.2 Data Encoding

MODBUS uses the big-endian approach. Big-endian sends the most significant byte first. For example, the hexadecimal number 0x1234 would be sent in order of 0x12 and 0x34.

3.1.3 MODBUS Data model

MODBUS data items are categorized into four types based on the distinction between inputs and outputs, and between bit-addressable and word-addressable.

Data	Access	R/W	Descriptions
Discrete Inputs	bit	Read Only	Provided by a device
Coils	bit	Read/Write	Controlled by an HMI/SCADA
Input Registers	16-bit word	Read Only	Provided by a device
Holding Registers	16-bit word	Read/Write	Controlled by an HMI/SCADA

Table 3-1 MODBUS Data Model

3.1.4 Memory structure of ezTCP

MODBUS standard doesn't define the memory structure of the device, so it depends on the vendor of the device. An ezTCP has only 1 data block. All data model items are mapped into 1 data block, which means the same data can be reached via several MODBUS functions, either via a 16-bit access or via an access bit.

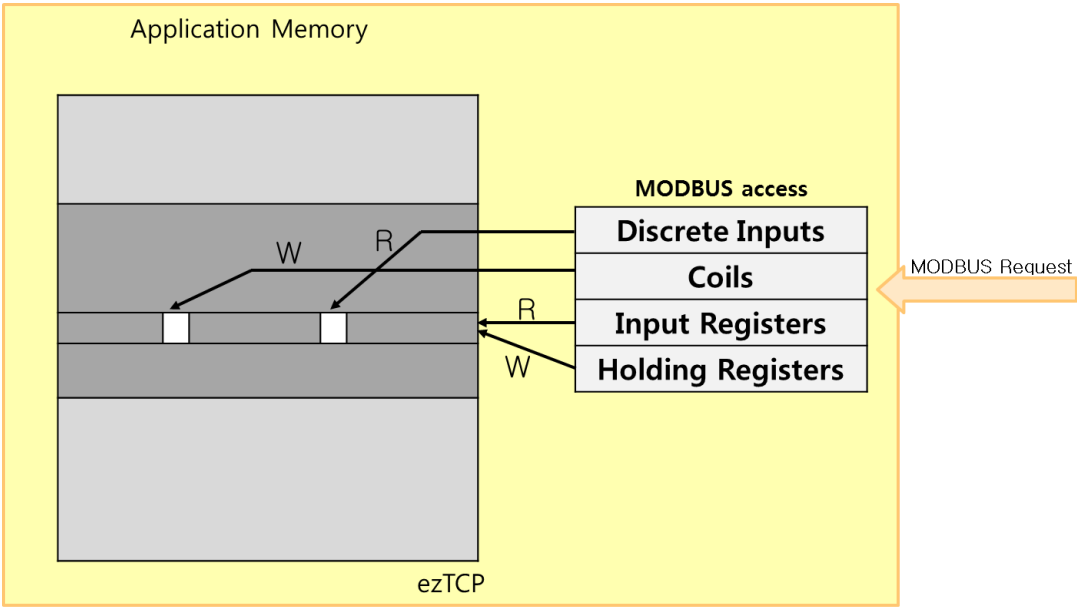

Figure 3-4 Memory structure of ezTCP

3.1.5 MODBUS Addressing by HMI/SCADA with ezTCP

In a MODBUS PDU, each data is addressed from 0 to 65535. On the other hand, in the MODBUS data model, each element within a data block is numbered from 1 to n.

Data	Reference on HMI/SCADA	Function Code	ezTCP
Coils	0X reference	01, 05, 15	Outputs (Digital)
Discrete Inputs	1X reference	02	Inputs (Digital)
Input Registers	3X reference	04	Inputs (Digital/Analog)
Holding Registers	4X reference	03, 06, 16	Inputs/Outputs (Digital/Analog)

Table 3-2 MODBUS Addressing with ezTCP

The examples below show MODBUS addressing in ezTCP.

- (Example 1) Digital Input Port Address – the parameter value is ‘0’ (Factory Default)

Value	Data	FC	Address on HMI/SCADA
0	Coils	01, 05, 15	Not Available
	Discrete Inputs	02	10001
	Input Registers	04	30001
	Holding Registers	03, 06, 16	40001

Table 3-3 Example of Input Ports Address

- (Example 2) Digital Output Port Address – the parameter value is ‘8’ (Factory Default)

Value	Data	FC	Address on HMI/SCADA
8	Coils	01, 05, 15	00009
	Discrete Inputs	02	Not Available
	Input Registers	04	Not Available
	Holding Registers	03, 06, 16	40009

Table 3-4 Example of Output Port Address



3.2 Modbus/TCP

3.2.1 General Description

- MODBUS protocol over TCP/IP network
- Connection oriented
 - As you can guess from its name, Modbus/TCP uses a TCP which is a reliable transport layer protocol. Modbus/TCP uses TCP port 502 as a default.

3.2.2 Communication Model in ezTCP

In the standard, Modbus/TCP protocol defines client/server model. The communication is initiated by a client, who sends a request, while a server responds to the client’s request by sending a response.

However, Modbus/TCP in ezTCP uses Master/Slave model. Both a master and a slave can be an initiator (TCP Client) by user configuration.

- Master
 - A master sends a request to a slave periodically. After then, a master waits for a response from a slave.
- Slave
 - When a request is arrived from a master, a slave sends a response to a master.

Note that a slave ezTCP, by using [Notify Input Port change] option, would send a response without any queries from a master when its status of input ports is changed.

3.2.3 Modbus/TCP Frame

The application data unit (ADU) for Modbus/TCP is as below:

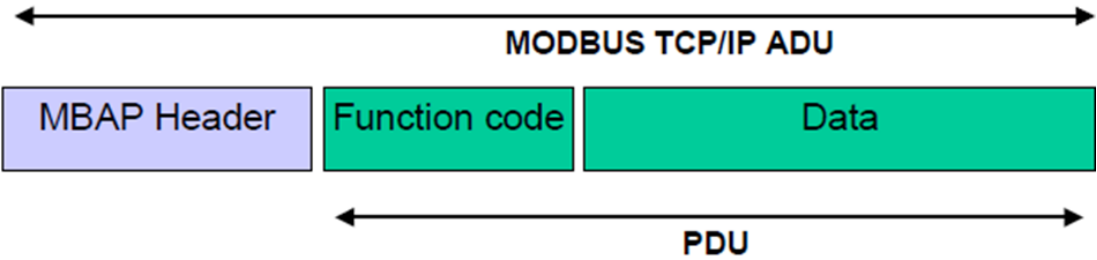

Figure 3-5 Modbus/TCP Frame

3.2.4 MBAP Header

The MBAP Header has 4 fields as below:

Fields	Length	Description
Transaction Identifier	2 bytes	Identification of a MODBUS request/response transaction
Protocol Identifier	2 bytes	0 = MODBUS protocol
Length	2 bytes	Number of following bytes
Unit Identifier	1 byte	Identification of a remote slave connected on a serial line or on other buses

Table 3-5 MBAP Header

Format of Modbus/TCP frame is described in the figure below.

MODBUS TCP Frame Structure

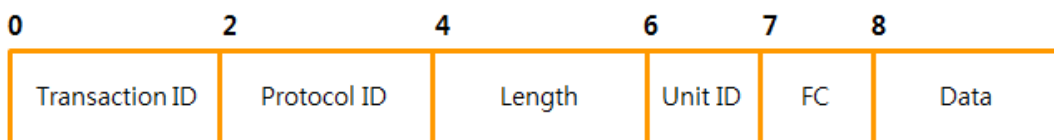

Figure 3-6 the format of Modbus/TCP frame

- byte 0 ~ 1: transaction ID (Transaction Identification)
This means the sequence number of queries and responses. While ezTCP operates as a master, it is incremented by one in every query (It does not matter if this field is set to 0x0000).
- byte 2 ~ 3: protocol ID(Protocol Identification)
This means the protocol identification and the value is fixed as 0x0000 for Modbus/TCP
- byte 4 ~ 5: length
The value of this means the number of bytes from next byte of length field to the end of the frame.
- byte 6: unit ID(Unit Identification)
☞ *ezTCP uses this field even though a remote slave is connected on TCP/IP network.*
- byte 7: FC (Function Code)
- byte 8~ : data depending on function code
☞ *The maximum size of the Modbus/TCP ADU is 260 bytes.*

3.3 Function Codes

3.3.1 Categories

The function code defines the service provided in MODBUS protocol. Valid codes are in the range of 1 ~ 255 decimal, but the range 128 ~ 255 is reserved and used for exception responses. There are three categories of MODBUS function codes as below.

- **Public Function Codes**
Publicly documented and validated by MODBUS.org community
1 ~ 64, 73 ~ 99, 111 ~ 127
- **User-Defined Function Codes**
Dependent on the vendor
65 ~ 72, 100 ~ 110
- **Reserved Function Codes**
Some of the Public Function Codes range, not available for public use but currently used by several companies for legacy products.
8/19, 8/21~65535, 9, 10, 13, 14, 41, 42, 90, 91, 125, 126, 127

Number	Function Codes
111 ~ 127	Public
100 ~ 110	User-Defined
73 ~ 99	Public
65 ~ 72	User-Defined
1 ~ 64	Public

Figure 3-7 Function Code Categories

3.3.2 Public Function Codes

Type	Access	Ports	Name	Function Codes		
				Code	Sub-code	
Data	Bit Access	Inputs (Digital)	Read Discrete Inputs	02 (0x02)		
		Outputs (Digital)	Read Coils	01 (0x01)		
			Write Single Coil	05 (0x05)		
			Write Multiple Coils	15 (0x0F)		
	16 bits Access	Inputs	Read Input Registers	04 (0x04)		
		Inputs Outputs	Read Holding Registers	03 (0x03)		
		Outputs	Write Single Register	06 (0x06)		
		Outputs	Write Multiple Registers	16 (0x10)		
	Diagnostics			Read Exception Status	07 (0x07)	
				Read Device Identification	43 (0x2B)	14 (0x0E)
Other			Encapsulated Interface Transport	43 (0x2B)		

Table 3-6 Public Function Codes in ezTCP

3.3.3 User-Defined Function Codes

Type	Access	Ports	Name	Function Codes	
				Code	Sub-code
Data	Bit Access	Outputs (Digital)	Write Pulse	105 (0x69)	

Table 3-7 User-Defined Function Code in ezTCP

☞ *Supported function codes in ezTCP can be different from the above tables depending on the product model and firmware version.*

4 Public Function Codes

4.1 Read Coils (FC 01)

This function code is used to read the status of digital outputs of ezTCP.

4.1.1 Request

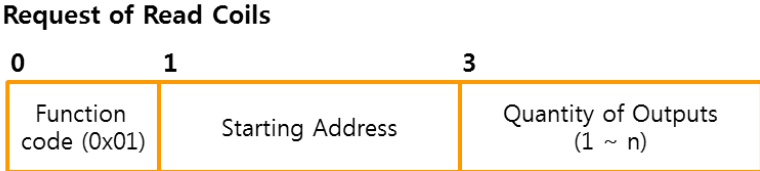

Figure 4-1 Request of Read Coils

- byte 0: Function Code
Function code of Read Coils is 0x01.
- byte 1~2: Starting Address
This is the address of the first digital output port to read.
- byte 3~4: Quantity of Outputs
Request PDU specifies the number of digital output ports ranging from 1 to n (1 ~ n).
☞ *n: the number of digital output ports for each ezTCP*

4.1.2 Response

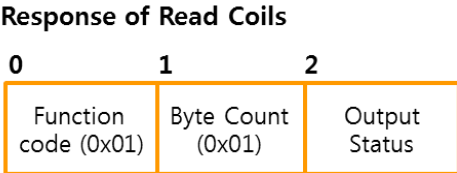

Figure 4-2 response of read coils

- byte 0: Function Code (0x01)
- byte 1: Byte Count (0x01)
(Quantity of Outputs + 7) / 8
- byte 2: Output Status
This value shows the status of digital output ports. The data in the response message is packed as one byte per eight outputs. And this value represents output ports as one port per bit from the LSB to the MSB. Status is indicated as 1= ON and 0= OFF. If the requested quantity is not a multiple of eight, the remaining bits in the final data byte will be padded with zeros (toward the high order end of the byte).



Figure 4-3 Status of Output Ports



4.1.3 Exception

Exceptions of Read Coils

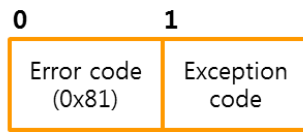

Figure 4-4 Exceptions of Read Coils

- byte 0: Error Code
Function code + 0x80,
- byte 1: Exception Code
Exception code can be 0x01, 0x02 or 0x03.

4.1.4 Examples

The example below shows reading digital output ports #0 ~ #7.

- Request

Example of Request

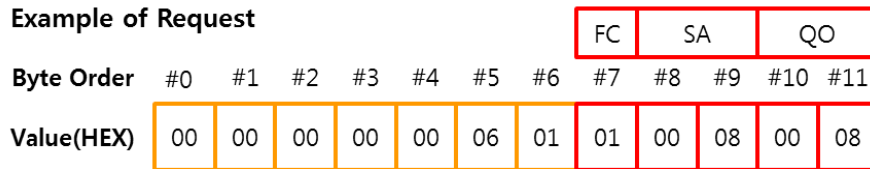

Figure 4-5 Request ADU

byte order	value	description
7	0x01	Function code
8~9	0x0008	Starting address to read is 8 (Factory default value for digital outputs of ezTCP).
10~11	0x0008	Read 8 digital output ports

Table 4-1 Request PDU

- Response

Example of Response

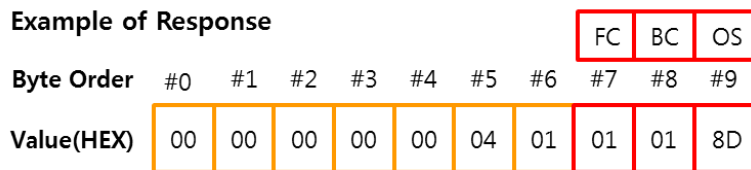

Figure 4-6 Response ADU

byte order	value	description
7	0x01	Function code
8	0x01	1 byte, 1 ~ 8 digital output ports
9	0x8D	(1000 1101) #0, 2, 3, 7 ON / #1, 4 ~ 6 OFF

Table 4-2 Response PDU

4.2 Read Discrete Inputs (FC 02)

This function code is used to read the status of digital inputs of ezTCP.

4.2.1 Request

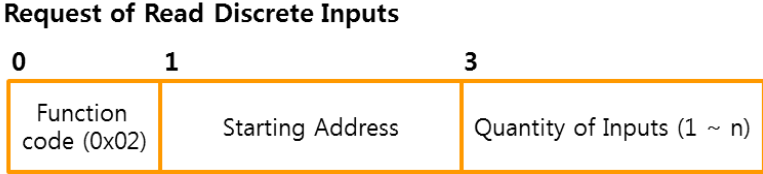

Figure 4-7 Request of Read Discrete Inputs

- byte 0: Function Code
Function code of Read Discrete Input is 0x02.
- byte 1~2: Starting Address
This is the address of the first digital input port to read.
- byte 3~4: Quantity of Inputs
Request PDU specifies the number of digital input ports ranging from 1 to n (1 ~ n).

☞ *n: the number of digital input ports for each ezTCP*

4.2.2 Response

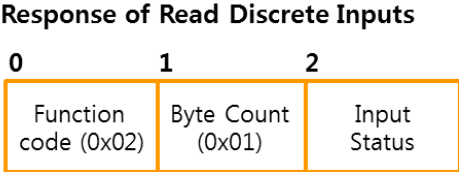

Figure 4-8 Response of Read Discrete Inputs

- byte 0: Function Code (0x02)
- byte 1: Byte Count (0x01)
(Quantity of Inputs + 7) / 8
- byte 2: Input Status
This value shows the status of digital input ports. The data in the response message is packed as one byte per eight inputs. And this value represents input ports as one port per bit from the LSB to the MSB. Status is indicated as 1= ON and 0= OFF. If the requested quantity is not a multiple of eight, the remaining bits in the final data byte will be padded with zeros (toward the high order end of the byte).



Figure 4-9 Status of Input Ports

4.2.3 Exception

Exceptions of Read Discrete Inputs

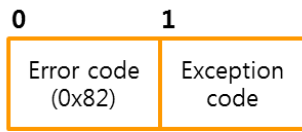

Figure 4-10 Exceptions of Read Discrete Inputs

- byte 0: Error Code
Function code + 0x80
- byte 1: Exception Code
Exception code can be 0x01, 0x02 or 0x03.

4.2.4 Examples

The example below shows reading digital input ports #0 ~ #7.

- Request

Example of Request

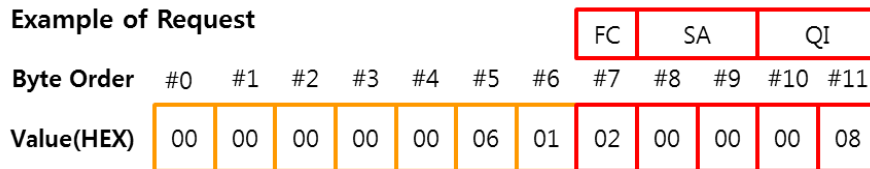

Figure 4-11 Request ADU

byte order	value	description
7	0x02	Function code
8~9	0x0000	Starting address to read is 0 (Factory default value for digital inputs of ezTCP).
10~11	0x0008	Read 8 digital input ports

Table 4-3 Request PDU

- an example of response

Example of Response

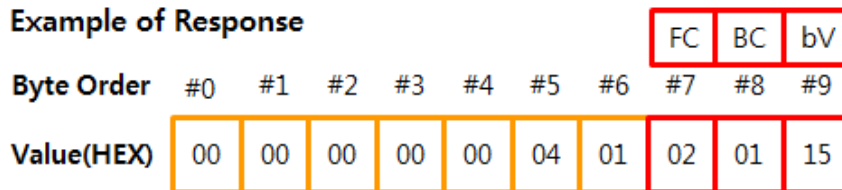

Figure 4-12 Response ADU

byte order	value	description
7	0x02	Function code
8	0x01	1 byte, 1 ~ 8 digital input ports
9	0x15	(0001 0101) #0, 2, 4 ON / #1, 3, 5 ~ 7 OFF

Table 4-4 Response PDU

4.3 Read Holding Registers (FC 03)

This function code is used to read the status of digital/analog inputs and digital outputs of ezTCP.

4.3.1 Request

Request of Read Holding Registers



Figure 4-13 Request of Read Holding Registers

- byte 0: Function Code
Function code of Read Holding Registers is 0x03.
- byte 1 ~ 2: Starting Address
This is the address of the first register to read. Registers are mapped to digital/analog inputs and digital outputs of ezTCP. This means that this function code can be used to access to all kinds of ports of ezTCP.

☞ available value for this address

Inputs Address (DIGITAL) – [Input Port Base Address]

Inputs Address (ANALOG) – [Input Port Base Address] + 4

Outputs Address (DIGITAL) – [Output Port Base Address]

- byte 3 ~ 4: Quantity of Registers
Request PDU specifies the number of registers. The available value for this field is 1 ~ 8.

4.3.2 Response

Response of Read Holding Registers

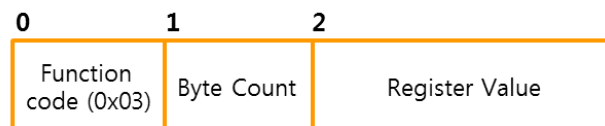

Figure 4-14 Response of Read Holding Registers

- byte 0: Function Code (0x03)
- byte 1 ~ 2: Byte Count
“Quantity of Registers” × 2
- byte 2 ~ 3: Register Value
This value shows the status of digital/analog input ports and digital output ports. The register data in the response message is packed as two bytes per register. And the register value represents digital ports as one port per bit from the LSB to the MSB. Status is indicated as 1= ON and 0= OFF. If there are bits mapped to nonexistent ports, they will be padded with zeros (toward the high order end of the register value).

Register Value for Digital Inputs / Outputs (DI / DO)



Figure 4-15 Register Value for Digital Ports

The register value also represents analog input ports with lower 10 bits ranging from 0 to 1023 as below.

Register Value for Analog Inputs (AI)



Figure 4-16 Register Value for Analog Ports

4.3.3 Exceptions

Exceptions of Read Holding Registers

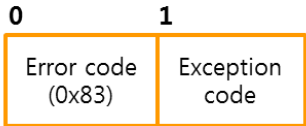

Figure 4-17 exceptions of read multiple registers

- byte 0: Error Code
Function code + 0x80
- byte 1: Exception Code
Exception code can be 0x01, 0x02 or 0x03

4.3.4 Examples

The example below shows reading input ports of ezTCP.

● Request

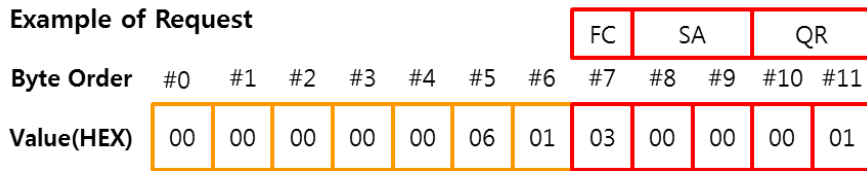

Figure 4-18 Request ADU

byte order	value	description
7	0x03	Function code
8~9	0x0000	Starting address to read is 0 (Factory default value for digital inputs of ezTCP)
10~11	0x0001	Read 1 register

Table 4-5 Request PDU

● Response

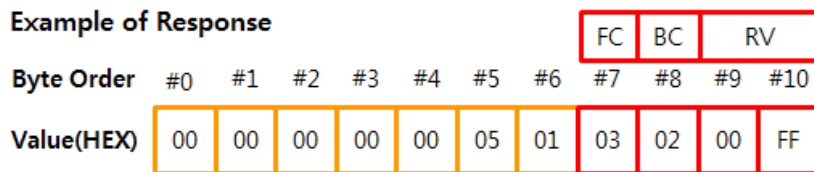

Figure 4-19 Response ADU

byte order	value	description
7	0x03	Function code
8	0x02	2 bytes, 1 register
9~10	0x00FF	(1111 1111) Digital Inputs #0 ~ 7 ON

Table 4-6 Response PDU

4.4 Read Input Registers (FC 04)

This function code is used to read the status of digital/analog inputs of ezTCP.

4.4.1 Request

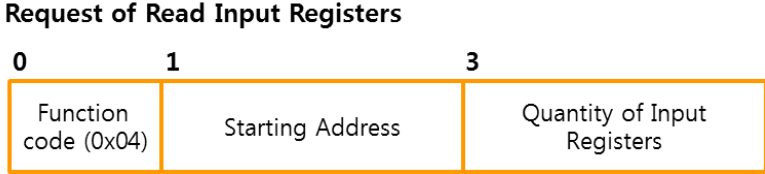

Figure 4-20 Request of Read Input Registers

- byte 0: Function Code
Function code of Read Input Registers is 0x04.
- byte 1~2: Starting Address
This is the address of the first register to read. Registers are mapped to digital/analog input ports of ezTCP. This means that this function code can be used to access to both digital and analog input ports of ezTCP.

☞ *available value for this address*
Inputs Address (DIGITAL) – [Input Port Base Address]
Inputs Address (ANALOG) – [Input Port Base Address] + 4

- byte 3~4: Quantity of Input Registers
Request PDU specifies the number of register. The available value for this field is 1 ~ 8.

4.4.2 Response

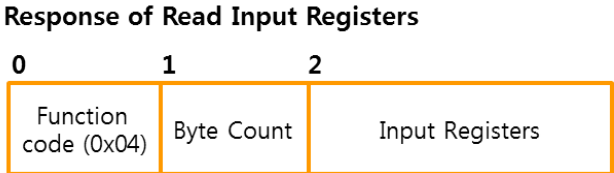

Figure 4-21 Response of Read Input Registers

- byte 0: Function Code (0x04)
- byte 1: Byte Count
“Quantity of Registers” × 2
- byte 2~3: Input Registers
This value shows the status of digital/analog input ports. The register data in the response message is packed as two bytes per register. And the register value represents digital ports as one port per bit from the LSB to the MSB. Status is indicated as 1= ON and 0= OFF. If there are bits mapped to nonexistent ports, they will be padded with zeros (toward the high order end of the register value).

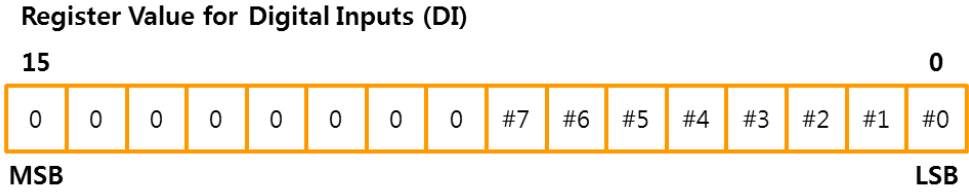

Figure 4-22 Register Value for Digital Input Ports

The register value also represents analog input ports with lower 10 bits ranging from 0 to 1023 as below.

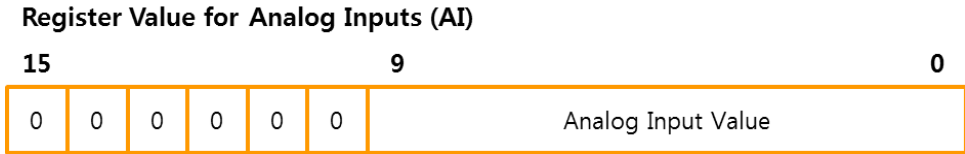

Figure 4-23 Register Value for analog ports

4.4.3 Exception

Exceptions of Read Input Registers

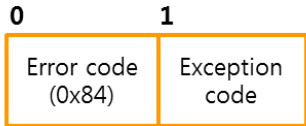

Figure 4-24 exceptions of read input registers

- byte 0: Error Code
Function code + 0x80
- byte 1: Exception Code
Exception code can be 0x01, 0x02 or 0x03.

4.4.4 Examples

The example below shows reading input ports of ezTCP.

● Request

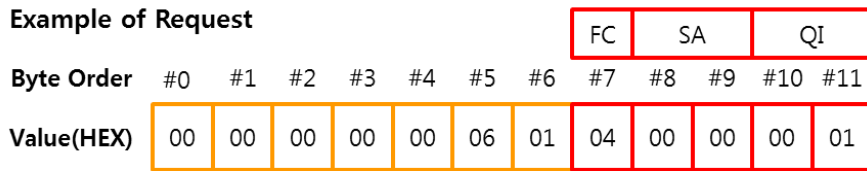

Figure 4-25 Request ADU

byte order	value	description
7	0x04	Function code
8~9	0x0000	Starting address to read is 0 (Factory default value for digital inputs of ezTCP)
10~11	0x0001	Read 1 register

Table 4-7 Request PDU

● Response

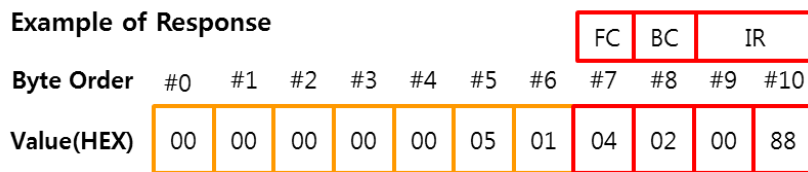

Figure 4-26 Response ADU

byte order	value	description
7	0x04	Function code
8	0x02	2 bytes, 1 register
9~10	0x0088	(1000 1000) #3, 7 ON / #0 ~ 2, 4 ~ 6 OFF

Table 4-8 Response PDU

4.5 Write Single Coil (FC 05)

This function code is used to control one digital output port.

4.5.1 Request / Response

Request / Response of Write Single Coil



Figure 4-27 Request / Response of Write Single Coil

- byte 0: Function Code
Function code of Write Single Coil is 0x05.
- byte 1~2: Output Address
This is the address of an output port to control.
- byte 3: Output Value
A value of 0xFF00 requests the output port to be ON. On the contrary, a value of 0x0000 requests the output port to be OFF. All other values are illegal and will not affect the output port.

☞ *The response ADU is identical to the request one.*

4.5.2 Exception

Exceptions of Write Single Coil

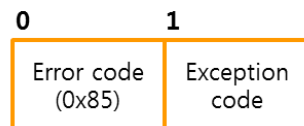

Figure 4-28 Exceptions of Write Single Coil

- byte 0: Error Code
Function code + 0x80
- byte 1: Exception Code
Exception code can be 0x01, 0x02, 0x03 or 0x04.

4.5.3 Examples

The following is an example of a request to write Output Port #0 ON:

● Request / Response

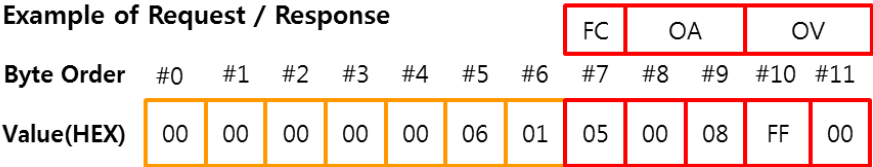

Figure 4-29 Request / Response ADU

byte order	value	description
7	0x05	Function code
8~9	0x0008	Output port address is 8 (Factory default value for the first digital output port)
10~11	0xFF00	Output port ON

Table 4-9 Request / Response PDU

4.6 Write Single Register (FC 06)

This function code is used to control digital output ports ON/OFF.

4.6.1 Request / Response

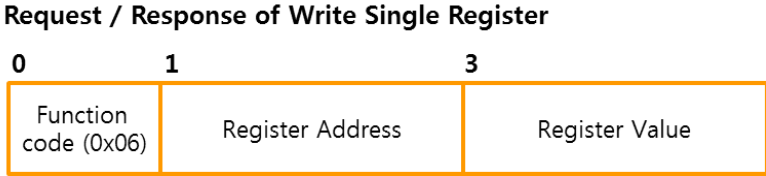

Figure 4-30 Request / Response of Write Single Register

- byte 0: Function Code
Function code of Write Single Register is 0x06.
- byte 1~2: Register Address
This is the output port address to control.
- byte 3~4: Register Value
This value is used to control output ports and packed as two bytes. It represents digital output ports as one port per bit from LSB to MSB. The value is indicated as 1= ON and 0= OFF. If there are bits mapped to nonexistent ports, they will be ignored.

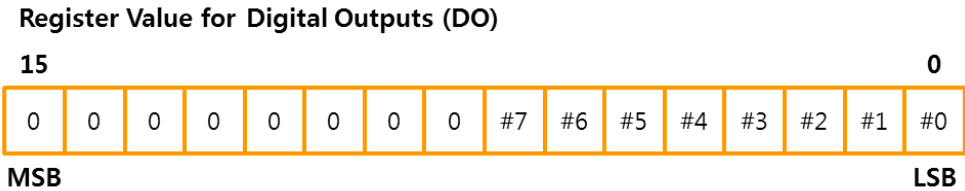

Figure 4-31 Register Value for the digital output ports

The response ADU is identical to the request one.

4.6.2 Exception

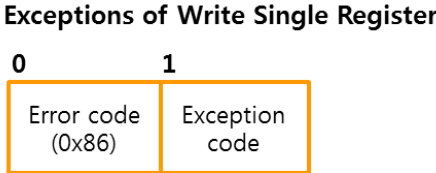

Figure 4-32 Exceptions of Write Single Register

- byte 0: Error Code
Function code + 0x80
- byte 1: Exception Code
Exception code can be 0x01, 0x02 or 0x04.

4.6.3 Examples

● Request / Response

Example of Request / Response

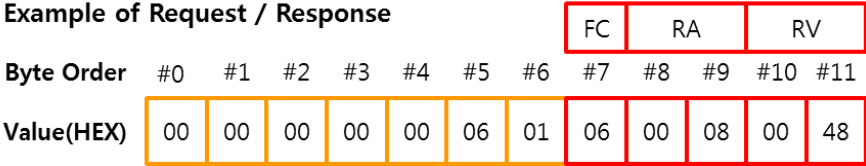

Figure 4-33 Request / Response ADU

byte order	value	description
7	0x06	Function code
8~9	0x0008	Resister address is 8 (Factory default value for the digital output port)
10~11	0x0048	(0100 1000) #3, 6 ON / #0 ~ 2, 4, 5, 7 OFF

Table 4-10 Request / Response PDU



4.7 Read Exception Status (FC 07)

Note that this function code is NOT relevant to 'Exception Response'. The 'Read Exception Status' is used to check if output ports of ezTCP operate as Macro mode.

4.7.1 Request

Request of Read Exception Status

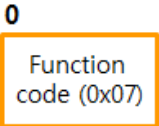

Figure 4-34 Request of Read Exception Status

- byte 0: Function Code
Function code of Read Exception Status is 0x07.

4.7.2 Response

Response of Read Exception Status

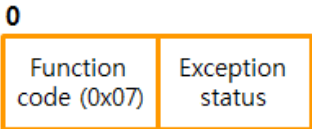

Figure 4-35 Response of Read Exception Status

- byte 0: Function Code (0x07)
- byte 1: Exception Status
This value represents the status of output ports operating mode from the LSB to the MSB. '1' indicates the port is operated as Macro mode and '0' indicates the port is not. LSB is assigned to the first port. If there are bits mapped to nonexistent ports, they will be padded with zeros (toward the high order end of the value).

4.7.3 Exception

Exceptions of Read Exception Status

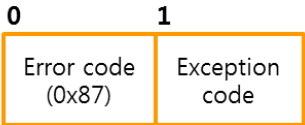

Figure 4-36 exceptions of read exception status

- byte 0: Error Code
Function code + 0x80
- byte 1: Exception Code
Exception code can be 0x01.

4.7.4 Examples

● Request

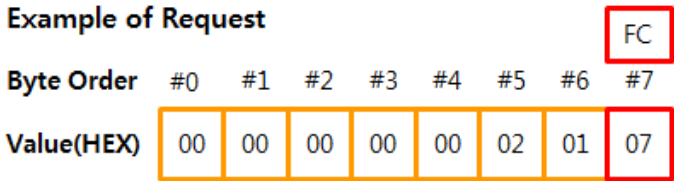

Figure 4-37 Request PDU

byte order	value	description
7	0x07	Function code is 7.

Table 4-11 Request PDU

● Response

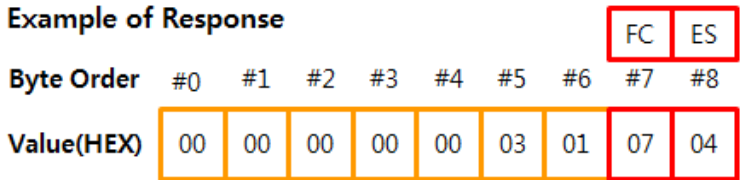

Figure 4-38 Response ADU

byte order	value	description
7	0x07	Function code
8	0x04	(0000 0100) output port #2 is Macro mode

Table 4-12 Response PDU

4.8 Write Multiple Coils (FC 15)

This function code is used to control multiple digital output ports at a single request.

4.8.1 Request

Request of Write Multiple Coils

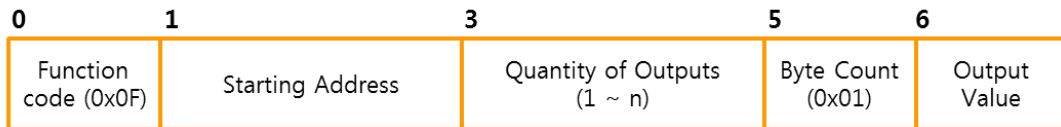

Figure 4-39 Request of Write Multiple Coils

- byte 0: Function Code
Function code of Write Multiple Coils is 0x0F.
- byte 1~2: Starting Address
This is the address of the first output ports to control.
- byte 3~4: Quantity of Outputs
Request PDU specifies the number of digital output ports ranging from 1 to n (1 ~ n).
☞ ***n: the number of digital output ports for each ezTCP***
- byte 5: Byte Count (0x01)
(Quantity of Outputs + 7) / 8
- byte 6: Output Value
This value is used to control output ports and packed as one byte per eight output ports from the LSB to the MSB. The bit value is indicated as 1= ON and 0= OFF. If there are bits mapped to nonexistent ports, they will be ignored.

Output Value for Digital Outputs (DO)



Figure 4-40 Output Value for the digital output ports

4.8.2 Response

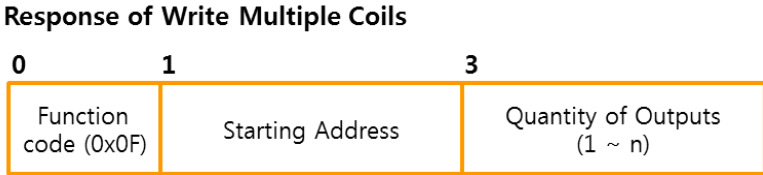

Figure 4-41 Response of Write Multiple Coils

- byte 0: Function Code (0x0F)
- byte 1~2: Starting Address
- byte 3~4: Quantity of Outputs

4.8.3 Exception

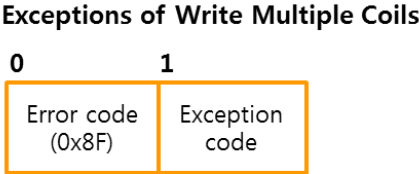

Figure 4-42 Exceptions of Write Multiple Coils

- byte 0: Error Code
Function code + 0x80
- byte 1: Exception Code
Exception code can be 0x01, 0x02, 0x03 or 0x04.

4.8.4 Examples

The example below shows controlling 4 digital output ports #0 ~ #3.

● Request

Example of Request

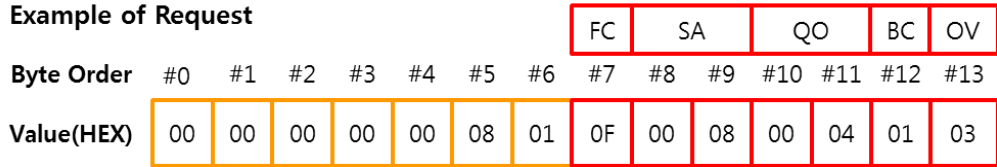

Figure 4-43 Request ADU

byte order	value	description
7	0x0F	Function code
8~9	0x0008	Starting address to control is 8 (Factory default value for digital outputs of ezTCP)
10~11	0x0004	Control 4 digital output ports
12	0x01	1 byte, 1 ~ 8 digital output ports
13	0x03	(0000 0011) #0, 1 ON / #2, 3 OFF

Table 4-13 Request PDU

● Response

Example of Response

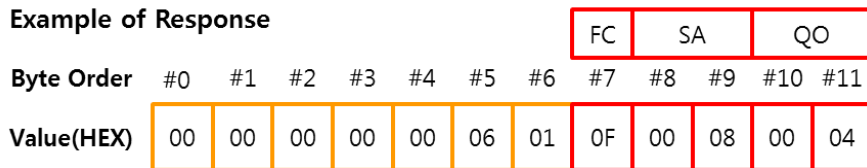

Figure 4-44 Response ADU

byte order	value	description
7	0x0F	Function code
8~9	0x0008	Starting address to control is 8 (Factory default value for digital outputs of ezTCP)
10~11	0x0004	Control 4 digital output ports

Table 4-14 Response PDU

4.9 Write Multiple Registers (FC 16)

4.9.1 Request

Request of Write Multiple Registers

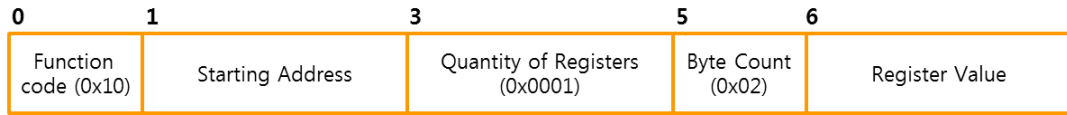

Figure 4-45 Request of Write Multiple Registers

- byte 0: Function Code
Function code of Write Multiple Registers is 0x10.
- byte 1~2: Starting Address
This is the address of the first register to write. Registers are mapped to digital output ports of ezTCP.
- byte 3~4: Quantity of Registers (0x0001)
Request PDU specifies the number of registers. The available value for this field is 1.
- byte 5: Byte Count (0x02)
Quantity of Registers × 2
- byte 6~7: Register Value
This value is used to control output ports and packed as two byte per one register from the LSB to the MSB. The bit value is indicated as 1= ON and 0= OFF. If there are bits mapped to nonexistent ports, they will be ignored.

Register Value for Digital Outputs (DO)



Figure 4-46 Register value for the digital output ports

4.9.2 Response

The response PDU is identical to the request one except the Byte Count and the Register Value.

Response of Write Multiple Registers



Figure 4-47 Response of Write Multiple Registers

- byte 0: Function Code (0x10)
- byte 1~2: Starting Address
- byte 3~4: Quantity of Registers (0x0001)

4.9.3 Exception

Exceptions of Write Multiple Registers

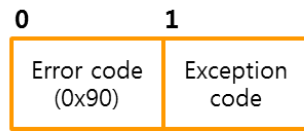

Figure 4-48 Exceptions of Write Multiple Registers

- byte 0: Error Code
Function code + 0x80
- byte 1: Exception Code
Exception code can be 0x01, 0x02, 0x03 or 0x04.

4.9.4 Examples

- an example of request

Example of Request

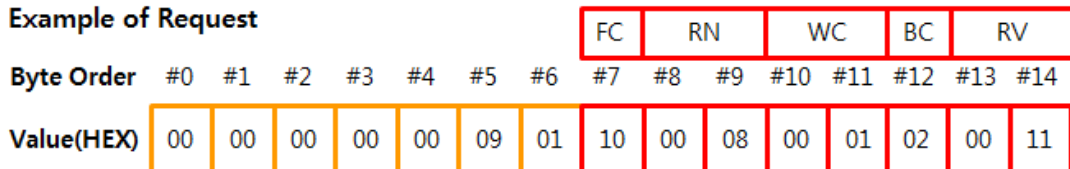

Figure 4-49 Request ADU

byte order	value	description
7	0x10	Function code
8~9	0x0008	Starting address to control is 8 (Factory default value for digital outputs of ezTCP)
10~11	0x0001	Write 1 register
12	0x02	2 bytes, 1 register
13~14	0x0011	(0001 0001) #0, 4 ON / #1 ~ 3, 5 ~ 7 OFF

Table 4-15 Request PDU

- an example of response

Example of Response

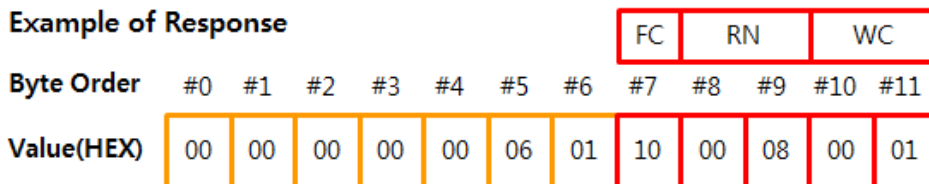

Figure 4-50 Response ADU

byte order	value	description
7	0x03	Function code
8~9	0x0008	Starting address to control is 8 (Factory default value for digital outputs of ezTCP)
10~11	0x0001	Write 1 register

Table 4-16 Response PDU

4.10 Encapsulated Interface Transport (FC 43)

This function code is designed for tunneling other protocols inside MODBUS. This mechanism is called MODBUS Encapsulated Interface (MEI) Transport. It is categorized to two types of MEI depending on capsulated protocols, one is 13 (0x0D)—CANopen General Reference and the other is 14 (0x0E)—Read Device Identification.

4.10.1 Request

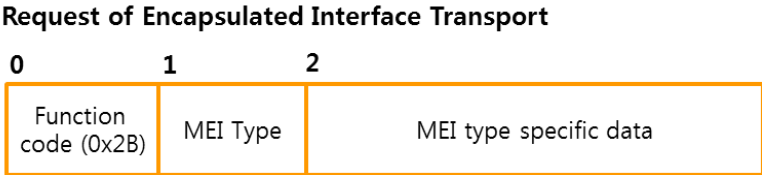

Figure 4-51 Request of Encapsulated Interface Transport

- byte 0: Function Code
Function Code of Encapsulated Interface Transport is 0x2B.
- byte 1: MEI Type (13 or 14)
ezTCP only supports 14 (0x0E)—Read Device Identification.

☞ **MEI: Modbus Encapsulated Interface**

- byte 2~: MEI type specific data (n bytes)
It is depending on the MEI Type.

4.10.2 Response

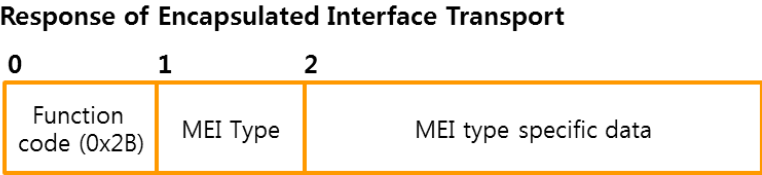

Figure 4-52 Response of Encapsulated Interface Transport

- byte 0: Function Code (0x2B)
- byte 1: MEI Type (0x0D or 0x0E)
- byte 2~: MEI type specific data (n bytes)

4.10.3 Exception

Exceptions of Encapsulated Interface Transport

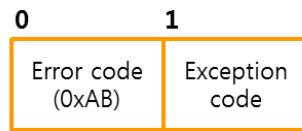

Figure 4-53 Exception of Encapsulated Interface Transport

- byte 0: Error Code
Function code + 0x80
- byte 1: Exception Code
Exception code can be 0x01, 0x02, 0x03 or 0x04.

4.10.4 Examples

Refer to [4.11 Read Device Identification \(FC 43 / 14\)](#).

4.11 Read Device Identification (FC 43 / 14)

This function code is used to confirm the device information called an object. Objects are categorized as below.

- Basic Device Identification
 - Regular Device Identification
 - Extended Device Identification
- ezTCP supports five objects for this device identification.

Type	Object ID	Object Name	Data Type	M/O
Basic	0x00	VendorName	ASCII String	Mandatory
	0x01	ProductCode	ASCII String	Mandatory
	0x02	MajorMinorRevision	ASCII String	Mandatory
Regular	0x03	VendorUrl	ASCII String	Optional
	0x04	ProductName	ASCII String	Optional
	0x05	ModelName	ASCII String	Optional
	0x06	UserApplicationName	ASCII String	Optional
	0x07~0x7F	Reserved		Optional
Extended	0x80	Comment	Binary	Optional
	0x81	MAC Address	ASCII String	Optional
	0x82	Macro Mode	Binary	Optional
	0xA0 + n	Input Comments	Binary	Optional
	0xB0 + n	Output Comments	Binary	Optional

Table 4-17 Object ID

☞ *n: the number of digital input and output ports for each ezTCP*

4.11.1 Request

Request of Read Device Identification

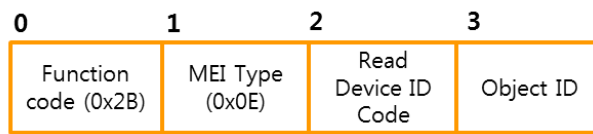

Figure 4-54 Request of Read Device Identification

- byte 0: Function Code (0x2B)
- byte 1: MEI Type (0x0E – Read Device Identification)
- byte 2: Read Device ID Code (0x01 / 0x02 / 0x03 / 0x04)
 Read Device ID Code allows to define four access types as the below:
 - 0x01: request to get the basic device identification (stream access)
 - 0x02: request to get the regular device identification (stream access)
 - 0x03: request to get the extended device identification (stream access)
 - 0x04: request to get the one specific identification object (individual access)

In case of a response that does not fit into a single response, several transactions (request/response) must be done. In case of the stream access, ezTCP needs three transactions to Extended Device Identification while it needs a single transaction to Basic/Regular Device Identification.

- byte 3: Object ID
 The Object ID field gives the identification of the first object to obtain.
 For the first transaction in case of stream access – 0x00
 For the following transaction in case of stream access – the value in its previous response
 In case of the individual access – the identification of the object to obtain

If the Object ID does not match any known object, the slave responds as if object 0 were requested. It means restart at the beginning.

4.11.2 Response

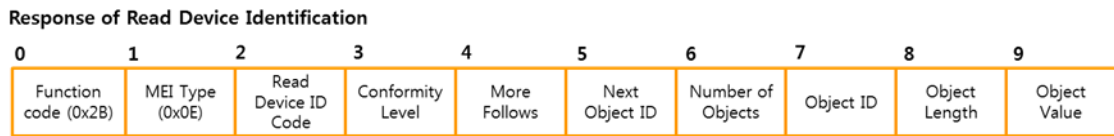

Figure 4-55 Response of Read Device Identification

- byte 0: Function Code (0x2B)
- byte 1: MEI Type (0x0E – Read Device Identification)
- byte 2: Read Device ID Code (0x01, 0x02, 0x03, 0x04) – identical to the request
- byte 3: Conformity Level
 Conformity Level represents supported access and object type.
 Conformity Level of ezTCP is 0x83.
 0x01: Basic identification (stream access only)
 0x02: Regular identification (stream access only)
 0x03: Extended identification (stream access only)
 0x81: Basic identification (stream/individual access)
 0x82: Regular identification (stream/individual access)
 0x83: Extended identification (stream/individual access)
- byte 4: More Follows
 In case of the stream access,
 0x00: no more Objects are available
 0xFF: other Objects are available and more MODBUS transactions are required.
 In case of the individual access, this value is fixed to 0x00.
- byte 5: Next Object ID
 When More Follows is 0xFF: the next Object to be asked by the following transaction
 When More Follows is 0x00: fixed to 0x00
- byte 6: Number of Objects
 Number of objects returned in the PDU (stream access)
 0x01 (individual access)
- byte 7: Object ID
 The first Object returned in the PDU (stream access)
 The requested Object (individual access)
- byte 8: Object Length
 Length of the first Object in byte
- byte 9~: Object Value
 Value of the first Object. If there are several objects in the PDU, Object ID/Object Length/Object Value are repeated in sequence.

4.11.3 Exception

Exceptions of Read Device Identification

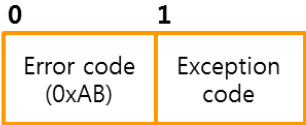

Figure 4-56 Exception of Read Device Identification

- byte 0: Error Code
Function Code + 0x80
- byte 1: Exception Code
Exception code can be 0x01, 0x02, 0x03 or 0x04.

4.11.4 Example – Basic Device Identification

- Request

Name	Value	Meaning
Function Code	0x2B	Function Code 43
MEI Type	0x0E	Read Device Identification
Read Device ID Code	0x01	Stream access to Basic Identification
Object ID	0x00	VendorName (beginning of the stream access)

Table 4-18 Request PDU

- Response

Name	Value	Meaning
Function Code	0x2B	Function Code 43
MEI Type	0x0E	Read Device Identification
Read Device ID Code	0x01	Stream access to Basic Identification
Conformity Level	0x83	Supports both stream and individual access for the all Identification
More Follows	0x00	No more transaction
Next Object ID	0x00	Last transaction
Number of Objects	0x03	Three objects in this PDU
Object ID	0x00	VendorName
Object Length	0x18	24 bytes
Object Data	“Sollae Systems Co., Ltd.”	
Object ID	0x01	ProductCode
Object Length	0x02	2 bytes
Object Data	“20”	Product Code of CIE-H10
Object ID	0x02	MajorMinorRevision
Object Length	0x05	5 bytes
Object Data	“V1.5B”	Firmware version 1.5B

Table 4-19 Response PDU

4.11.5 Example – Extended Device Identification

- Request 1

Name	Value	Meaning
Function Code	0x2B	Function Code 43
MEI Type	0x0E	Read Device Identification
Read Device ID Code	0x03	Stream access to Extended Identification
Object ID	0x00	Comment (beginning of the stream access)

Table 4-20 Request PDU 1

- Response 1

Name	Value	Meaning
Function Code	0x2B	Function Code 43
MEI Type	0x0E	Read Device Identification
Read Device ID Code	0x03	Stream access to Extended Identification
Conformity Level	0x83	Supports both stream and individual access for the all Identification
More Follows	0xFF	Further transactions
Next Object ID	0xA0	Input Comments
Number of Objects	0x03	Three objects in this PDU
Object ID	0x80	Comment
Object Length	0x00	0 byte
Object ID	0x81	MAC Address
Object Length	0x11	17 bytes
Object Data	“00:30:F9:00:00:01”	MAC address
Object ID	0x82	Macro Mode
Object Length	0x01	1 byte
Object Data	0x81	#0, 7 Macro mode ON

Table 4-21 Response PDU 1

- Request 2

Name	Value	Meaning
Function Code	0x2B	Function Code 43
MEI Type	0x0E	Read Device Identification
Read Device ID Code	0x03	Stream access to Extended Identification
Object ID	0xA0	Input Comments

Table 4-22 Request PDU 2

● Response 2

Name	Value	Meaning
Function Code	0x2B	Function Code 43
MEI Type	0x0E	Read Device Identification
Read Device ID Code	0x03	Stream access to Extended Identification
Conformity Level	0x83	Supports both stream and individual access for the all Identification
More Follows	0xFF	Further transactions
Next Object ID	0xB0	Output Comments
Number of Objects	0x08	Eight objects in this PDU
Object ID	0xA0	Input port #0 Comment
Object Length	0x03	3 bytes
Object Data	"DI0"	Default value
Object ID	0xA1	Input port #1 Comment
Object Length	0x03	3 bytes
Object Data	"DI1"	Default value
Object ID	0xA2	Input port #2 Comment
Object Length	0x03	3 bytes
Object Data	"DI2"	Default value
Object ID	0xA3	Input port #3 Comment
Object Length	0x03	3 bytes
Object Data	"DI3"	Default value
Object ID	0xA4	Input port #4 Comment
Object Length	0x03	3 bytes
Object Data	"DI4"	Default value
Object ID	0xA5	Input port #5 Comment
Object Length	0x03	3 bytes
Object Data	"DI5"	Default value
Object ID	0xA6	Input port #6 Comment
Object Length	0x03	3 bytes
Object Data	"DI6"	Default value
Object ID	0xA7	Input port #7 Comment
Object Length	0x03	3 bytes
Object Data	"DI7"	Default value

Table 4-23 Response PDU 2

● Request 3

Name	Value	Meaning
Function Code	0x2B	Function Code 43
MEI Type	0x0E	Read Device Identification
Read Device ID Code	0x03	Stream access to Extended Identification
Object ID	0xB0	Output Comments

Table 4-24 Request 3

● Response 3

Name	Value	Meaning
Function Code	0x2B	Function Code 43
MEI Type	0x0E	Read Device Identification
Read Device ID Code	0x03	Stream access to Extended Identification
Conformity Level	0x83	Supports both stream and individual access for the all Identification
More Follows	0x00	No more transaction
Next Object ID	0x00	Last transaction
Number of Objects	0x08	Eight objects in this PDU
Object ID	0xB0	Output port #0 Comment
Object Length	0x03	3 bytes
Object Data	"DO0"	Default value
Object ID	0xB1	Output port #1 Comment
Object Length	0x03	3 bytes
Object Data	"DO1"	Default value
Object ID	0xB2	Output port #2 Comment
Object Length	0x03	3 bytes
Object Data	"DO2"	Default value
Object ID	0xB3	Output port #3 Comment
Object Length	0x03	3 bytes
Object Data	"DO3"	Default value
Object ID	0xB4	Output port #4 Comment
Object Length	0x03	3 bytes
Object Data	"DO4"	Default value
Object ID	0xB5	Output port #5 Comment
Object Length	0x03	3 bytes
Object Data	"DO5"	Default value
Object ID	0xB6	Output port #6 Comment
Object Length	0x03	3 bytes
Object Data	"DO6"	Default value
Object ID	0xB7	Output port #7 Comment
Object Length	0x03	3 bytes
Object Data	"DO7"	Default value

Table 4-25 Response PDU 3

5 User-Defined Function Codes

5.1 Write Pulse (FC 105)

This function is used to make a pulse operation to the digital output port of ezTCP. Note that it is not specified in the standard of Modbus/TCP.

5.1.1 Request / Response

Request / Response of Write Pulse

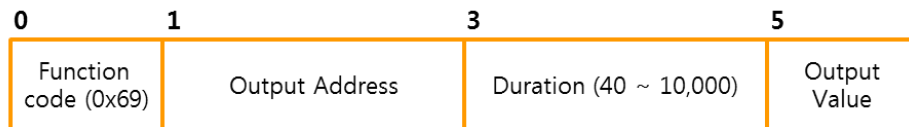

Figure 5-1 Request / Response of Write Pulse

- byte 0: Function Code
Function code of Write Pulse is 0x69.
- byte 1~2: Output Address
This is the address of an output port to control.
- byte 3~4: Duration (unit: millisecond)
The unit is millisecond. The available range of this value is from 40 to 10000 (0x0028 ~ 0x2710).
- byte 5: Output Value
A value of 0xFF requests the output port to make a high (ON) pulse operation. On the contrary, a value of 0x00 requests the output port to make a low (OFF) pulse. All other values are illegal and will not affect the output port. If this value is the same to the current output port status, the exception response will be returned with exception code 0x04.

☞ *The response ADU is identical to the request one.*

5.1.2 Exception

Exceptions of Write Pulse

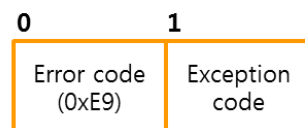

Figure 5-2 Exceptions of Write Pulse

- byte 0: Error Code (0xE9)
Function code + 0x80
- byte 1: Exception Code
Exception code can be 0x01, 0x02, 0x03 or 0x04.

5.1.3 Examples

● Request / Response

Example of Request / Response

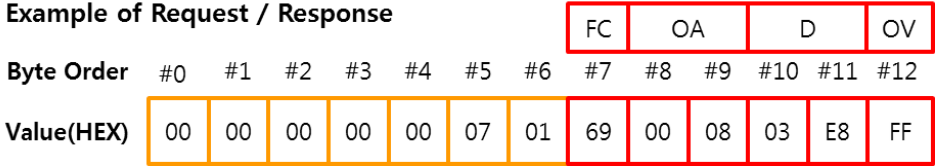

Figure 5-3 Request / Response ADU

byte order	value	description
7	0x69	Function code is 105.
8~9	0x0008	Output port address is 8 (Factory default value for the first digital output port)
10~11	0x03E8	Duration is 1 second. (1000ms = 0x03E8)
12	0xFF	Data value is 0xFF (ON for the duration)

Table 5-1 Request / Response PDU

☞ *If a port is either operating in the Macro mode or being controlled by the previous FC 105, the request is not accepted.*

6 Additional Instructions

6.1 Exception Codes

Exception Code	Name	Description
0x01	Illegal Function	Function code error
0x02	Illegal Data Address	Starting address error
0x03	Illegal Data Value	Data value error
0x04	Server Device Failure	Request action is failed

Table 6-1 Exception Codes

6.2 ADC values

6.2.1 Request

The analog input (ADC) ports of ezTCP can be read by FC 03 (Read Holding Registers) or FC 04 (Read Input Register). This ADC port is mapped to [Input Port Base Address] + 4. For example, if the [Input Port Base Address] is set to zero, the register address for the ADC port is 4(0x0004). See the below example (It is identical except FC field in case using FC 04) below.

- an example of request

		FC	SA	QR								
Byte Order	#0	#1	#2	#3	#4	#5	#6	#7	#8	#9	#10	#11
Value(HEX)	00	00	00	00	00	06	01	03	00	04	00	01

Figure 6-1 an example of request

6.2.2 Response

You can read the value of ADC port from the last two bytes of a command response of read multiple registers.

- an example of response

		FC	BC	RV							
Byte Order	#0	#1	#2	#3	#4	#5	#6	#7	#8	#9	#10
Value(HEX)	00	00	00	00	00	05	01	03	02	02	7F

Figure 6-2 an example of response

In the above example, ADC value is 0x02 0x7f in hexadecimal. (639 in decimal)

- ☞ *The ADC port of CIE-M10 has 10 bit resolution. (0 ~ 1,023)*

6.3 Using

6.3.1 Modbus/TCP Configuration

- CIE-M10/H12/H14/H10

With ezManager, search the products and configure the values in the box ③.

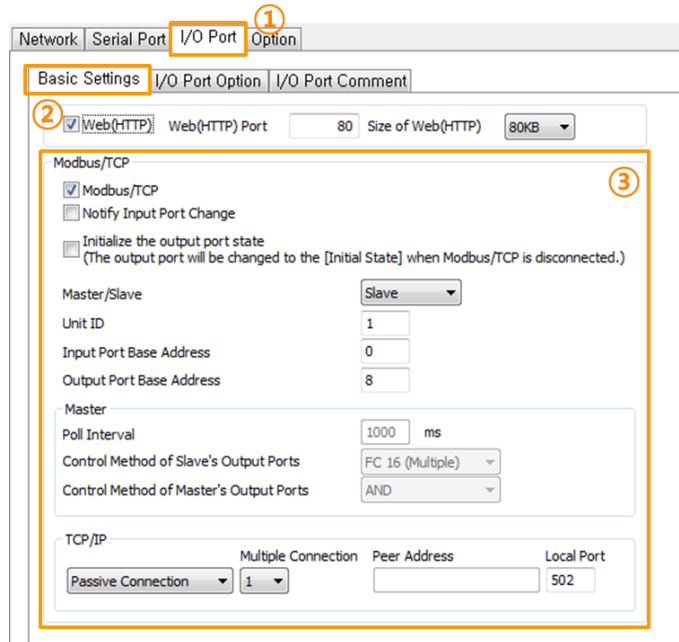

Figure 6-3 Configuration for Modbus/TCP on ezManager

- EZI-10

With ezConfigIO, search the products and configure the values in the orange box.

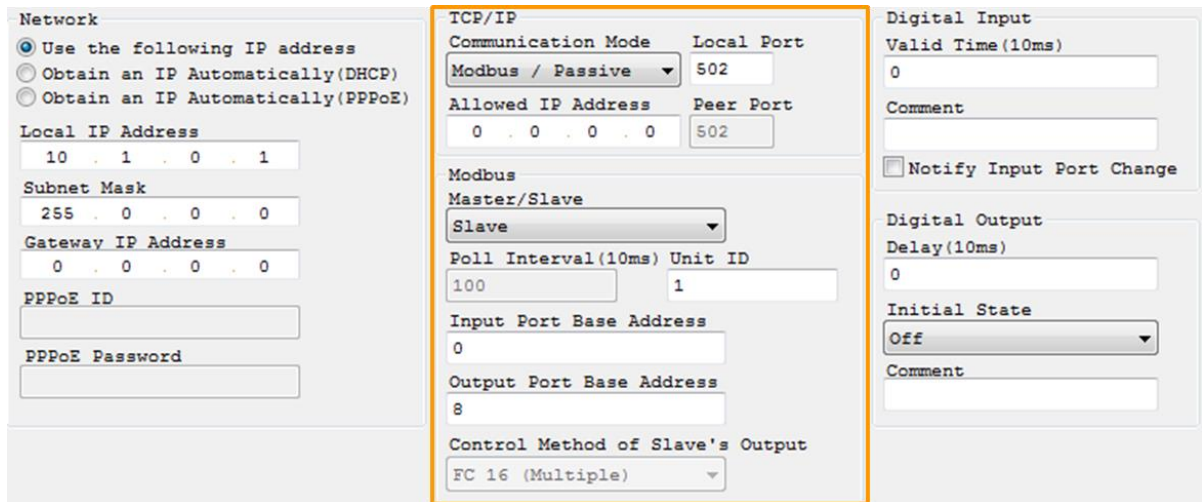

Figure 6-4 Configuration for Modbus/TCP on ezConfigIO

● Parameters

parameters	description
Modbus/TCP	Whether the Modbus/TCP use or not.
Notify Input Port Change	When input status is changed, the slave sends response without any requests from the master.
Master/Slave	Operation Type.
Poll Interval	Interval for sending query (Unit: millisecond)
Unit ID	ID for the pair of the master and slave
Input Port Base Address	The address for the first input port
Output Port Base Address	The address for the first output port
Control Method of (FCXX)	Control method for output ports of slave (Single / Multiple)
Control Method of (AND/OR)	Control method for output ports of master (AND/OR)
Active/Passive Connection	Active or Passive connection
Multiple Connection	Activation of multiple connection (1 ~ 8)
Peer Address	Peer's IP address under active connection
Peer Port	Peer's port number

Table 6-2 Parameters of Modbus/TCP

6.3.2 Configuration Example

parameters	ezTCP	another ezTCP or Modbus/TCP program
Local IP Address	192.168.0.10	192.168.0.20
Subnet Mask	255.255.255.0	255.255.255.0
Modbus/TCP	Check or Select	-
Master / Slave	Slave	Master
Poll Interval	-	1,000ms (1 sec)
Unit ID	1	1
Input Port Base Address	0	0
Output Port Base Address	8	8
Active/Passive Connection	Passive	Active
Multiple Connection	3	-
Peer Address	-	192.168.0.10
Peer Port	-	502
Local Port	502	-

Table 6-3 an example of configuration

6.4 Sample Codes

We have been offering sample codes for users who will make Modbus/TCP application program to use our I/O controllers. The codes can be downloaded from the [DOWNLOAD] >> [Download] page on our web site. (<http://www.eztcp.com/en/download/pds.php>)

☞ *Click the [Search] button after select [Sample Code] from the [DOWNLOAD] category.*

6.4.1 Provided version

- C++ (Visual Studio 6.0)
- C++ (Visual Studio 2008)
- Basic (Visual Basic)
- C (Linux)

7 Serialized Modbus/TCP

Serialized Modbus/TCP mode is for only CIE-M10, CIE-H10 and CIE-H14. The other communication modes are all disabled when using this mode. The RS232 port is used for this.

7.1 Features

- Sending and Receiving the Modbus/TCP data through the RS232
- Controlling digital I/O ports via a serial port
- No connection processes
In this mode, devices (or terminals) sends and receives data without any connection processes. Use the hardware flow control (RTS/CTS) to prevent data loss.

7.2 Using

7.2.1 Configuration

- Serialized Modbus/TCP configuration

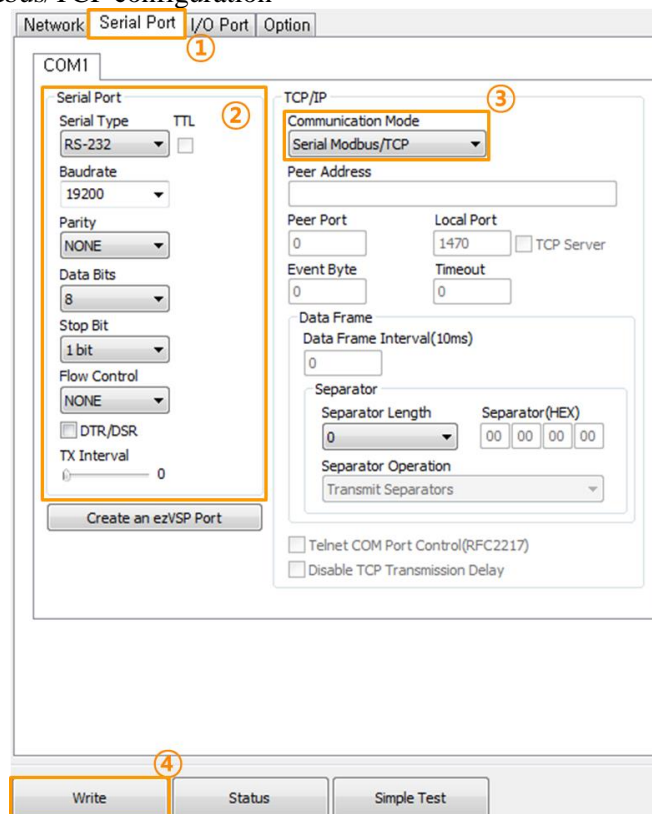

Figure 7-1 configuration of serialized Modbus/TCP

- ① Move to the [Serial Port] tab.
- ② Set and check parameters for the serial port.
- ③ Select [Serialized Modbus/TCP] on the [Communication Mode].
- ④ Press the [Write] button for saving.

7.3 Trial Run

7.3.1 Preparations for Communication

For testing the serialized Modbus/TCP mode, design the connection as follows:

☞ **Connection via an Ethernet cable is not required.**

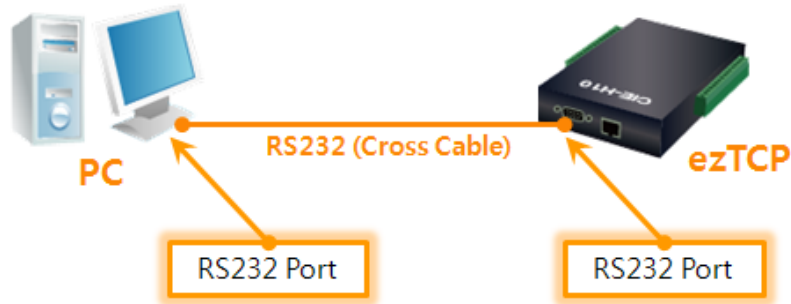

Figure 7-2 connection diagram

Then, for the test, the default value of Modbus/TCP setting has to be kept as follows:

Name	Default Value
Modbus/TCP	Checked
Notify Input Port Change	Unchecked
Master / Slave	Slave
Poll Interval	1,000
Unit ID	1
Input Port	0
Output Port	8

Table 7-1 default values for the parameters

7.3.2 Sending an Example data

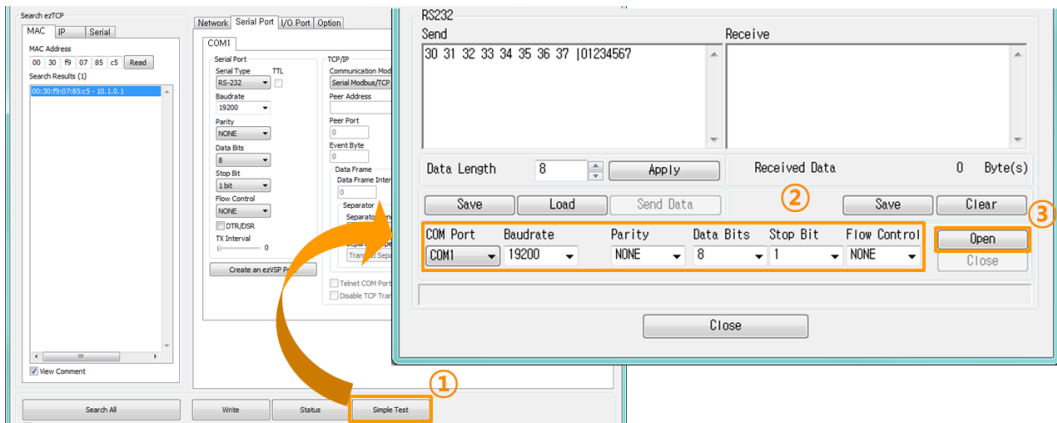

Figure 7-3 Run Simple Test Program

- ① Click the [Simple Test] button.
- ② Select and check all the parameters related with the serial port.
- ③ Press the [Open] button.

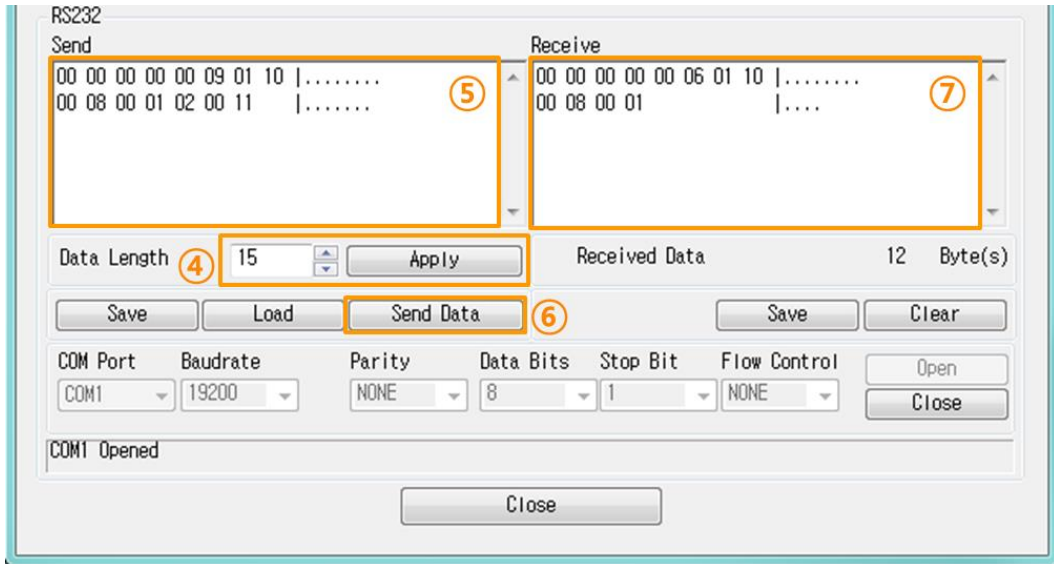

Figure 7-4 Send an example data

- ④ Click the [Apply] button after setting the [Data Length] to 15 bytes.
- ⑤ Input the data which is used in the example data of write multiple registers.
- ⑥ Press the [Send Data] button.
- ⑦ Check the real output ports of ezTCP if the response data in the [Receive] box is same with the above figure.

☞ The data sent on the step ⑤ means turning on the output port #0 and #4 (Write Multiple Registers). The slave should respond to the data appeared on the step ⑦.

8 Precautions

- This document describes the Modbus/TCP protocol that ezTCP supports based on the standard MODBUS protocol specifications.
- The information presented in this document is subject to change without prior notice.
- It is assumed all contents in this document are accurate and reliable, but it does NOT mean we guarantee it.
- For the detailed information, refer to the MODBUS Application Protocol Specification (v1.1b3) and MODBUS Messaging Implementation Guide (v1.0b).



9 Revision History

Date	Version	Comments	Author
2010.03.08.	1.0	○ Initial Release	Roy LEE
2010.07.20.	1.1	○ Name of the document has been changed ○ Contents of the Modbus/TCP document has been included ○ Contents about the EZI-10 has been added	Roy LEE
2010.11.23.	1.2	○ Descriptions about querying/response of ADC values have been added ○ Date item on the front page has been removed.	Roy LEE
2011.06.24.	1.3	○ Contents about new functions have been added. (FC 1, 2, 4, 5, 6, 7, 15, 105) ○ Most of figures have been updated. ○ Figures about configuration tools have been updated. ○ Document structure has been redesigned. ○ Title of document has been changed.	Roy LEE
2014.04.30.	1.4	○ Add description about MODBUS data and addressing ○ Contents about new functions have been added. (FC 43, FC 43 / 14) ○ Most of figures and description have been updated. ○ Figures about configuration tools have been updated. ○ Document structure has been redesigned. (delete function code class categorization and etc.)	Andy Lee
2015.02.13.	1.5	○ Typo correction	Andy Lee
2017.08.04.	1.6	○ Fix MODBUS addressing description errors ○ Delete sample code descriptions and fix link errors	Andy Lee